

CONOCE TU BICI

POR BÁSICA

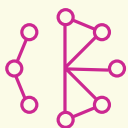
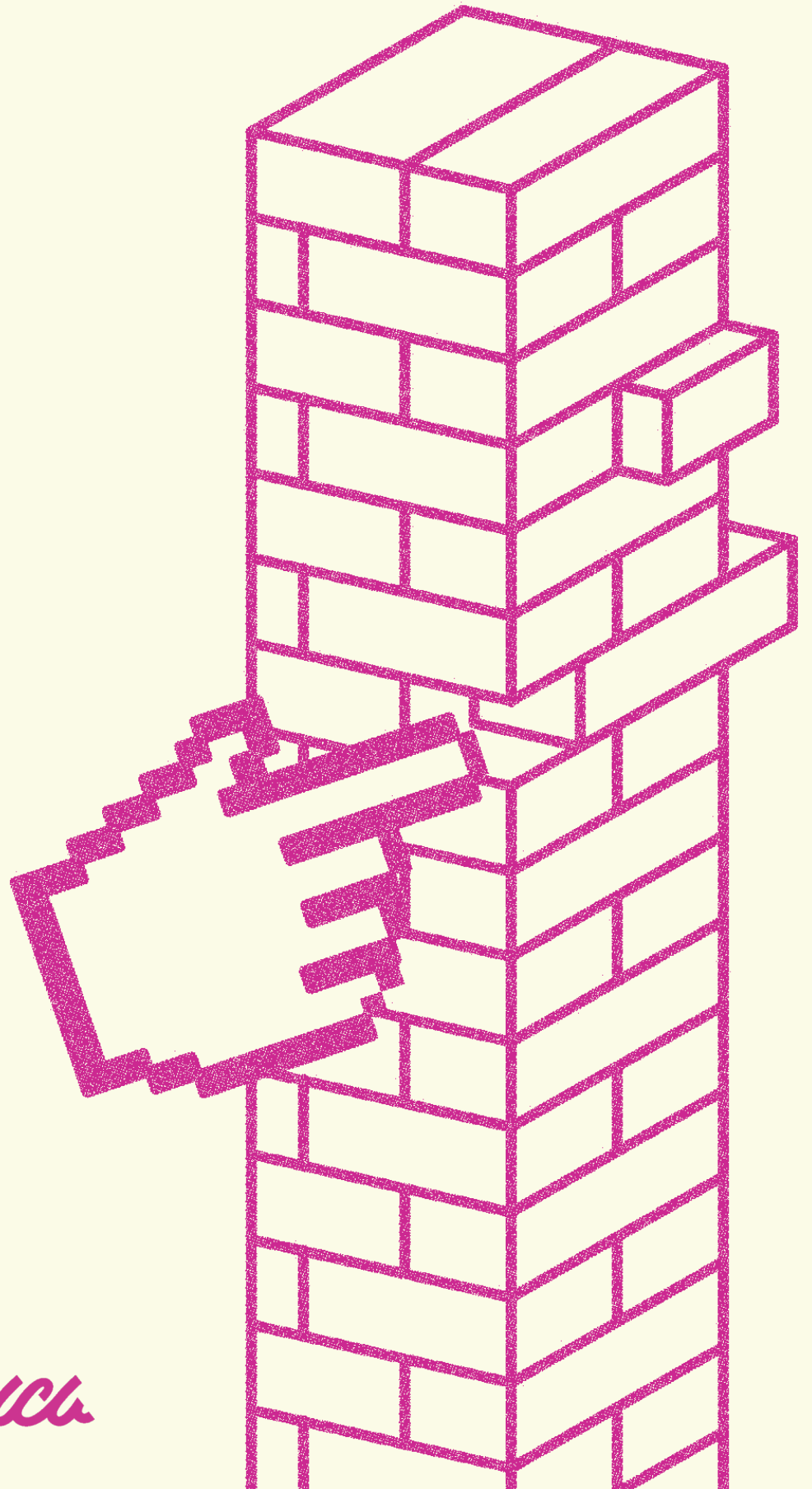

CENTRO
DECULTURA
DIGITAL

básica

Mi Bici ♡

Es tipo:



Es de color:

Es de la marca:



Estalla:

Tiene frenos:



Es de rodada:



Usa llantas y cámaras de medida:

Tiene ---- plato(s)

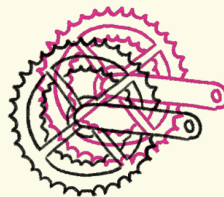

Tiene ---- piñones



Características particulares:

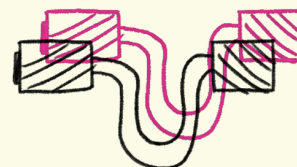



COMPONENTES

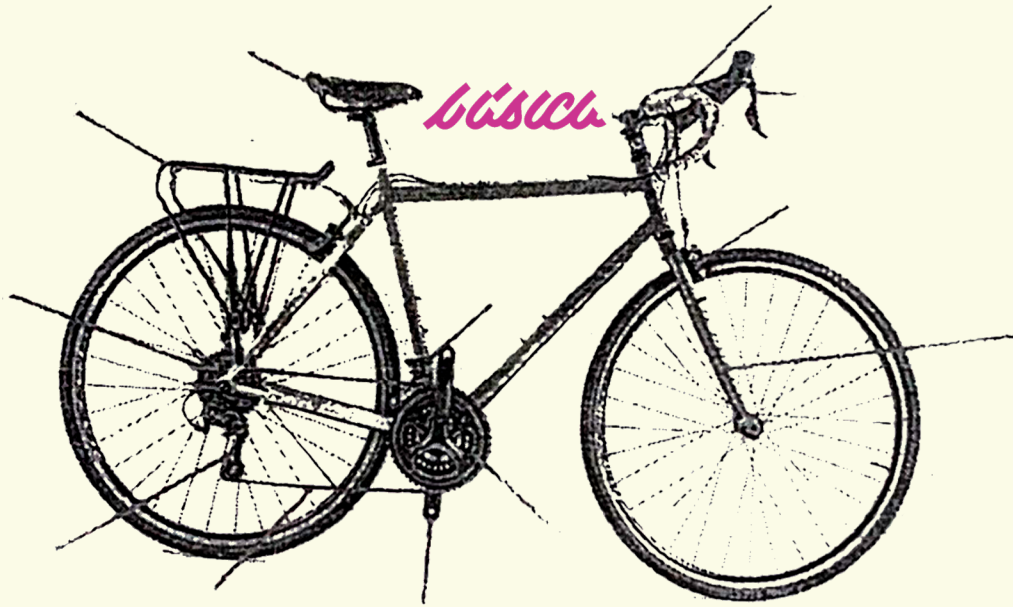

NOTAS:

TIPOS

DE

BICIS



BICIS

MANUBRIOS

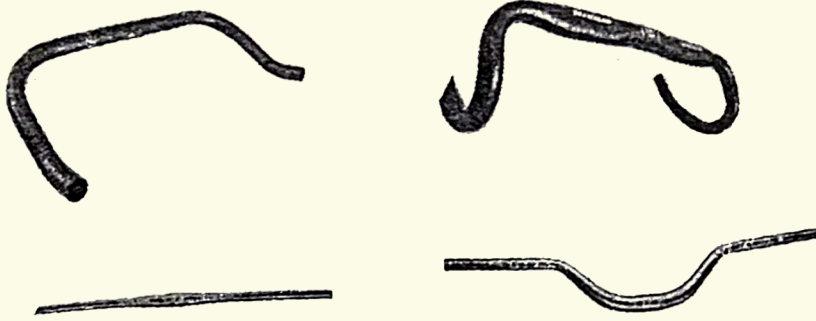

ESTÁNDAR
22.2

POTENCIAS



OVER
31.8



Wish

→ RIN

→ LLANTA

→ CÁMARA

RUEDAS

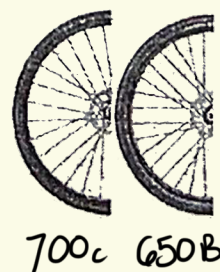
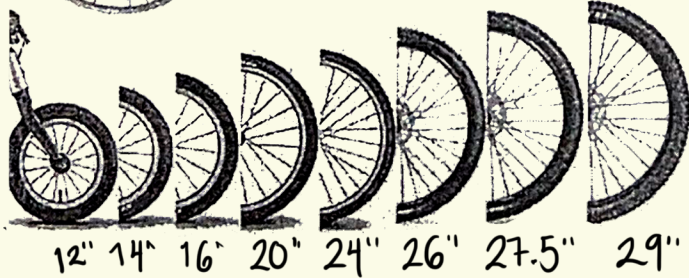
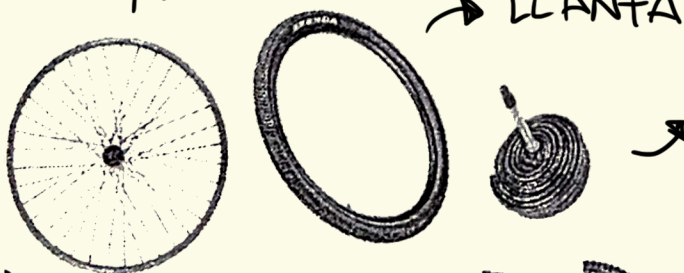

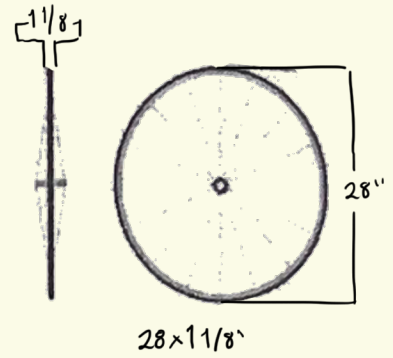
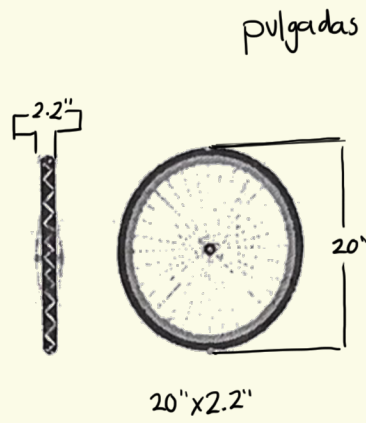
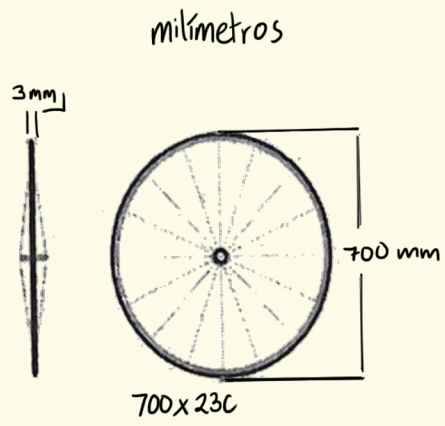

FRENOS

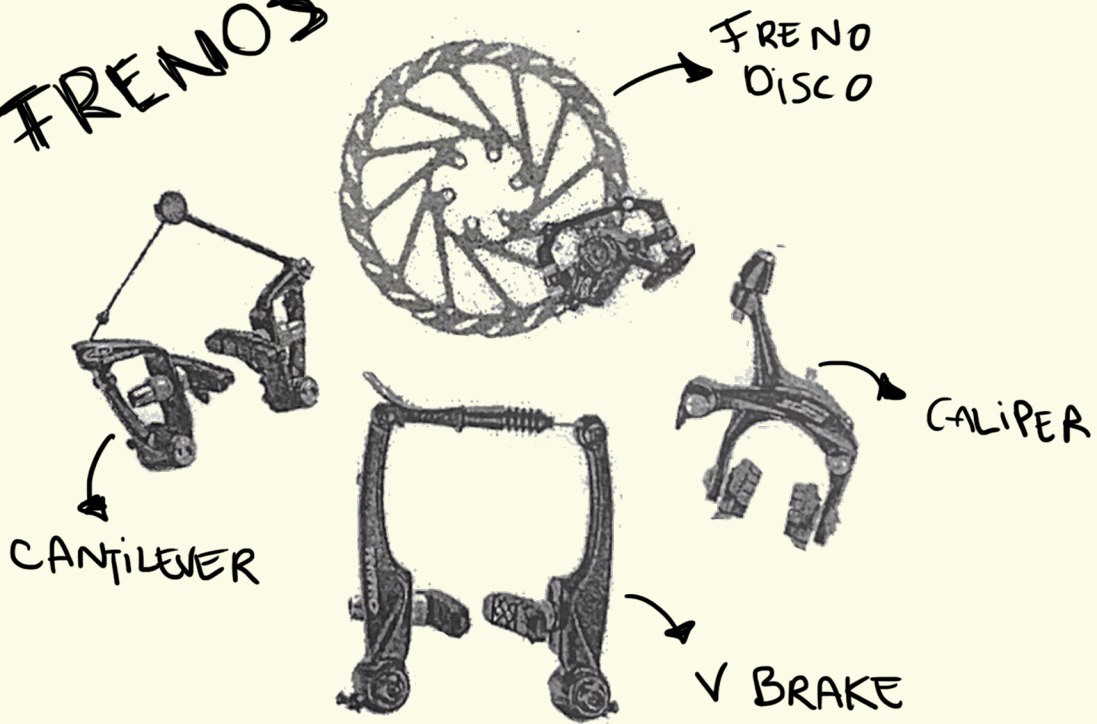

WUOL

Conoce tu bici!

TRANSMISIÓN

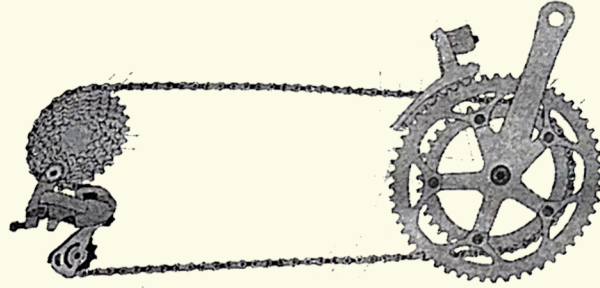

DESVIADOR
TRASERO

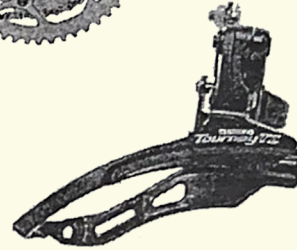

DESVIADOR
DELANTERO

✗ NO CRUZAR CADENA



✓ PLATO CHICO / PIÑON GRANDE

✓ PLATO GRANDE / PIÑON CHICO

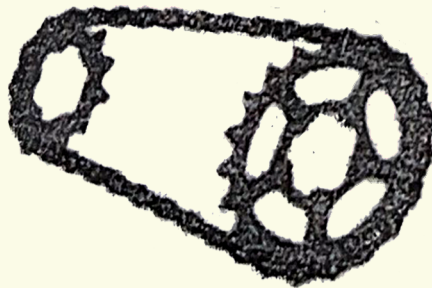

✓ MANTENER CADENA
LUBRICADA Y LIMPIA





* MULTÍ HERRAMIENTA:

- LLAVES ALLEN
- CORTA CADENA
- DESARMADORES
- DADOS

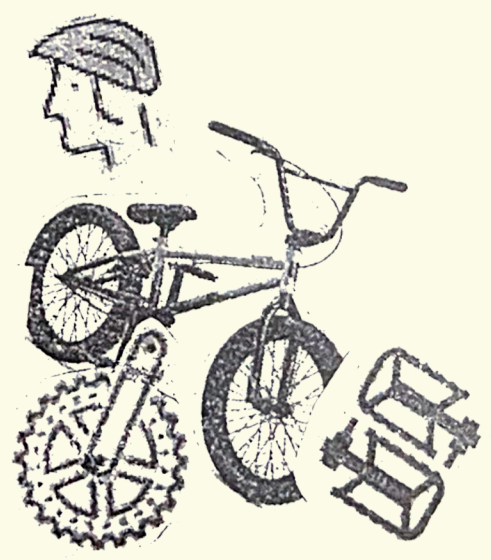



↳ CASCO



↳ V-LOCK

ACCESORIOS DE SEGURIDAD

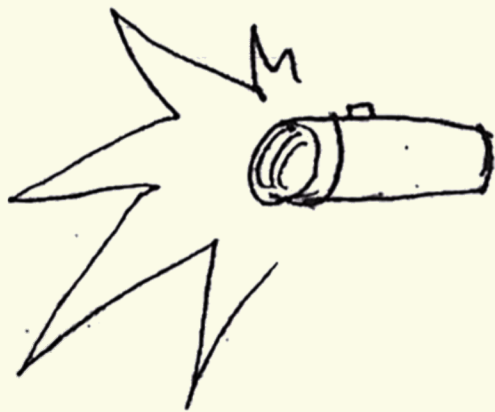

↳ LUZ BLANCA



↳ LUZ ROJA

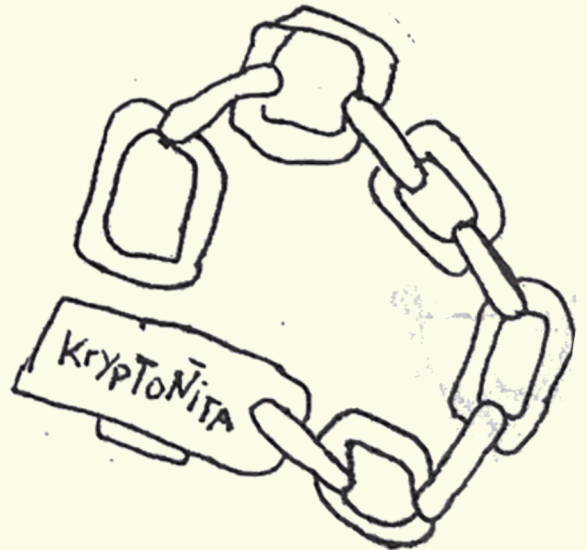

↳ CADENA

ANOTACIONES

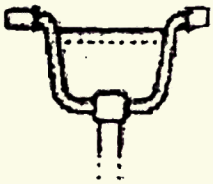
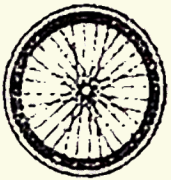

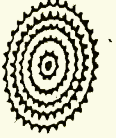

basica



MARSELLA #17 JUÁREZ

5550559592

@BASICASTUDIO